

Figure 1. Modular construction permits choice of plug-ins to make the pulse generator you want.

**CONTENTS  
OF  
THIS ISSUE**

	Page
Pulses to Order . . . . .	3
Remote Programming for GR Synthesizers . . . . .	20



## PULSES TO ORDER

The TYPE 1395-A Modular Pulse Generator is a pulse kit of almost infinite possibilities. With it one can construct, to suit his requirements or his fancy, a practically infinite number of pulse shapes and combinations. As shown in Figure 1, the generator consists of a number of basic modules and a frame to hold them. The photograph shows only one of 38,400 combinations that can be assembled from currently available modules.

Of course, some selection must be made among these capabilities; the Modular Pulse Generator will not do everything at once. So the next matter to consider is what modules are available, what functions they perform, and how they can be combined for maximum usefulness.

The TYPE 1395-A Modular Pulse Generator produces any or all of the following signals:

- conventional rectangular pulses
  - pulse bursts
  - doublet pulses
  - pulses with pedestals
  - ascending and descending staircases
  - triangles
  - trapezoids
  - peculiar pulses
  - single pulses
  - binary patterns or words from 2 to 112 bits long
- In addition, it
- locks on higher frequencies up to ratios of about 15:1
  - scales in true digital fashion by any quantity that can be formed as the product of up to 7 numbers between 2 and 16
  - generates time delays
  - operates at pulse repetition frequencies as low as 2.5 c/s and up to 1.5 Mc/s internally; down to dc and up to 2 Mc/s with external drive
  - allows noise or sine waves to be added to pulses
  - gives independent control over amplitudes, durations, and delays in all parts of complex pulses
  - amplifies the pulses it produces (up to 400 mA in 50 ohms)
  - gives both positive and negative polarities simultaneously

One of the first commercial pulse generators was the General Radio Type 869-A,<sup>1</sup> designed and built originally for defense research projects in World War II. Square-wave generators, among them the GR Type 769-A, had been available for some years and were widely used for transient response measurements.<sup>2</sup> For design and test of pulsed equipment such as radar, television, and pulse-modulated communication systems, however, test signals of variable duty-cycle and fast rise and fall times were needed. The Type 869-A filled the bill in the early days. It was followed by the Type 1391-A Pulse, Sweep, and Time-Delay Generator and the Type 1217 Unit Pulse Generator, of which the current Type 1217-C is the latest design. The new Type 1395-A Modular Pulse Generator goes several steps further and allows the user to build pulses of practically any shape that he wishes.

<sup>1</sup> H. H. Scott and C. A. Cady, "The General Radio Pulse Generator," *General Radio Experimenter*, January-February 1945.  
<sup>2</sup> L. B. Argimbaum, "Network Testing with Square Waves," *General Radio Experimenter*, December 1939; "Transient Response of a Broadcast System," *Ibid.*, April 1940.

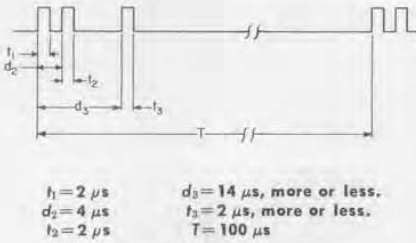

Figure 2. A design objective

AVAILABLE MODULES

An initial complement of six modules is offered for this instrument.

**Type 1395-P1 PRF Unit.** A master clock, generating pulses for synchronizing and triggering other plug-ins. It also provides gating and locking functions and accepts external drive signals, buffering them to other modules.

**Type 1395-P2 Pulse/Delay Unit.** Generates rectangular pulses from 0.1 microsecond to 1.1 seconds, choice of positive or negative polarity or both simultaneously. Generates time delays from 0.1 microsecond to 1.1 seconds.

**Type 1395-P3 Pulse Shaper.** Gives independent control over the rise and fall times of leading and trailing edges of pulses. Rise and fall times can be varied from 0.1 microsecond to 10,000 microseconds; the only restriction is that both times must be within the same decade range.

**Type 1395-P4 Power Amplifier.** Makes big pulses out of little ones. Up to 400 mA into 50-ohm load; also matches 93- and 600-ohm loads. Offers variable dc baseline, variable input impedance. Low distortion allows its use on sine waves and assures faithful reproduction of pulses of complicated shapes. Upper half-power frequency: 5 Mc/s with low impedance loads; 1.5 Mc/s with 600-ohm load.

**Type 1395-P6 Word Generator.** A binary word generator, providing up to 16 bits of ones and zeros per module. Modules can be cascaded, so that as many as 112 bits are possible in a single main frame. Can also be used as a digital scaler.

**Type 1395-P7 Skeleton Frame.** An empty module, having only the rear-panel power plug. You can build your own auxiliary circuits into this module.

APPLICATIONS

To demonstrate the versatility of this pulse generator, we have selected, from the almost infinite number of possible applications, a few examples drawn from a representative assortment of disciplines.

Something from the Communications Art

Suppose that the problem arises of testing a communications system using

Figure 3. Simulation of PDM or PPM with the Type 1395 Modular Pulse Generator.





either pulse-duration (width) modulation (PDM or PWM) or pulse-position modulation (PPM). Such a system usually involves time multiplexing, and so a synchronizing pulse is required. We assume this to be a doublet, so the test signal might take the form of Figure 2.

There are three pulse durations to be set up and two delay intervals, indicated by  $t_1, t_2, t_3$ , and  $d_2, d_3$ , respectively. Thus, five Pulse/Delay Units are required. One master clock, a PRF Unit, generates the 10-kc repetition frequency corresponding to the period of 100 microseconds.

The necessary connection of modules is illustrated in Figure 3. Six units are required altogether. The right-hand space is covered with a blank panel. Four such panels are furnished with each instrument, on the assumption that at least three plug-ins will always be used. Figure 4 shows an oscillogram of the pulses actually generated.

In Figure 2, several times were given as "more-or-less." These are the times that would be varied during the simulation of PPM or PDM. However, *any* of the three pulses can be varied in amplitude and duration, and even reversed in polarity! Both of the time delays are completely adjustable.

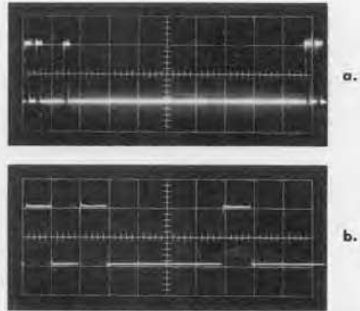

Figure 4. (a) The waveform sketched in Figure 2. Scale: Vertical, 0.5 volt per major division; horizontal, 10 microseconds per major division. (b) Enlargement of the left-hand area of Figure 4(a). Scale: Vertical, 0.5 volt per major division; horizontal, 2 microseconds per major division.

#### An Application from the Encoder Art

Let us consider the case of testing an analog-to-digital converter. Several rapidly cycling levels are required to verify that the encoder is operating both quickly and correctly. A staircase waveform is recommended for this application. Figure 5 shows how to get it.

Here one master clock drives six Pulse/Delay Units. Each of these has an output lasting at least 1 microsecond. Therefore, for 1 microsecond, the sum of all the contributions at the ADDER terminal is 6 units. After 1 microsecond, the first Pulse/Delay Unit output ends, leaving 5 units of ampli-

Figure 5. Generating a negative staircase.



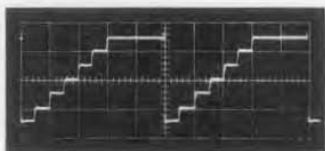

Figure 6. A staircase designed to test an analog-to-digital converter. Scale: Vertical, each step in the staircase is 0.75 volt; horizontal, 2 microseconds per major division.

tude for another microsecond. The process continues until after 6 microseconds the waveform is back at the baseline. The resulting staircase is shown in Figure 6. The dc voltage is adjustable by a front-panel control marked PULSE DC COMPONENT, a most useful feature. In Figure 6, this control has been set to place 0 volts dc at the center of the oscilloscope graticule. Therefore, there are three positive voltages, ground, and three negative levels available to test the encoder. The entire pattern repeats at a rate of 100 kc/s.

#### An Unusual Quality-Control Application

A pre-production model of the TYPE 1395-A Modular Pulse Generator has been in use at General Radio Company for several months, testing the reversible counters used in our TYPE 1680-A Automatic Capacitance Bridge

Assembly. The problem here is to be sure the counters count correctly both forward and backwards. The technique is to apply 17 pulses, then rest for about one-half second to let the inspector read the number stored in the counter. After the first 9 pulses, a reverse command is applied to the counters. The net result is that they count forward nine times, backward eight times, and therefore the number shown is just one digit larger each time the count is interrupted for display.

This is an interesting problem because it demonstrates several properties of the modules not shown in the previous examples. These are the *locking* and *gating* functions. In order to keep all action coherent in time, one PRF Unit is used as a system master clock, running continuously at 1 kc/s. This triggers the EXTERNAL DRIVE terminal of a Pulse/Delay Unit, fourth from left in Figure 7. It also drives the LOCKING terminal of the PRF Unit in the second-from-left position. This PRF Unit locks at 1/15th the original frequency, or about 67 c/s. Its output drives still a third PRF Unit LOCKING input. The third PRF Unit locks at about 1/25th of the 67 c/s, or approximately 2.7 c/s. The exact value of this lowest frequency doesn't matter, as

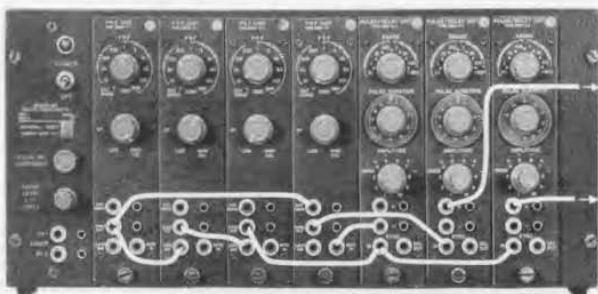

Figure 7. The Modular Pulse Generator testing reversible counters.

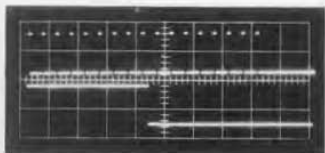

Figure 8. A test pattern for checking reversible counters. The burst of 17 pulses is interpreted as nine forward counts and eight reverse counts. The forward-reverse command is given by the step in the bottom half of the picture. Scale: Vertical, none (waveforms placed on scope to give best display of principle involved); horizontal, 2 milliseconds per major division.

long as the operator has time enough to read the number appearing on the counter.

The 2.7-cycle PRF Unit triggers two Pulse/Delay Units. One generates a pulse 17 milliseconds long; the second gives a 9-millisecond pulse. The 17-millisecond pulse controls the gate of the same PRF Unit that receives the 1-ke external drive from the master clock. Note that, even though the operating frequency has been dropped to 2.7 c/s, everything is tied to the master. There is no possibility of the gate closing in time to cause a "half pulse" and give an ambiguous result. Exactly 17 pulses come out. These trigger another Pulse/Delay Unit (6th from left), which generates pulses of the proper duration and amplitude to operate the counter being tested.

At the same time the 17 pulses start, the last unit on the right generates a pulse 9 milliseconds long. This tells the counters to count forward. Nine counts are added in, followed by 8 subtracted back out. The net result is the +1 count we were seeking. And this occurs slowly enough (2.7 times per second) to allow the inspector to see that the counters are operating properly. The pulses generated for this test are shown in Figure 8.

### A Problem in Signal Detection

One truly handy feature of the TYPE 1395-A Modular Pulse Generator is the provision for external access to the adder circuits. These adders are normally used for combining pulses of different durations and amplitudes in order to produce pulses of complicated form. But noise, sine waves, or other signals can be injected as well.

Suppose that a pulse signal similar to that shown in Figure 9b is expected but must be detected in the presence of noise. The pulse as actually received is shown in Figure 9a. We want to simulate this signal in order to adjust our detector circuits for optimum response. Obviously the first step is to generate a "clean" pattern. Then the noise is added to it.

Figure 10 gives the configuration for producing the desired results. A PRF Unit, as always, acts as a master clock. The first Pulse/Delay Unit generates a negative-going pulse 300 microseconds in duration. This is connected to the adder. The second Pulse/Delay Unit serves as delay only. This starts a 100-microsecond time interval at the same

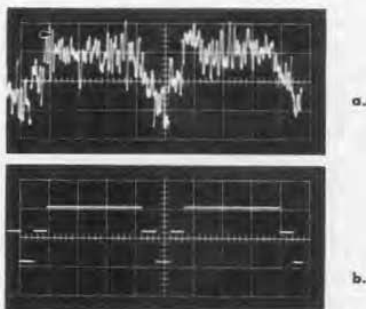

Figure 9. (a) A noisy pulse train, taken with single sweep on the oscilloscope. (b) The same signal without noise. Scale: Vertical, 0.5 volt per major division; horizontal, 0.2 millisecond per major division.

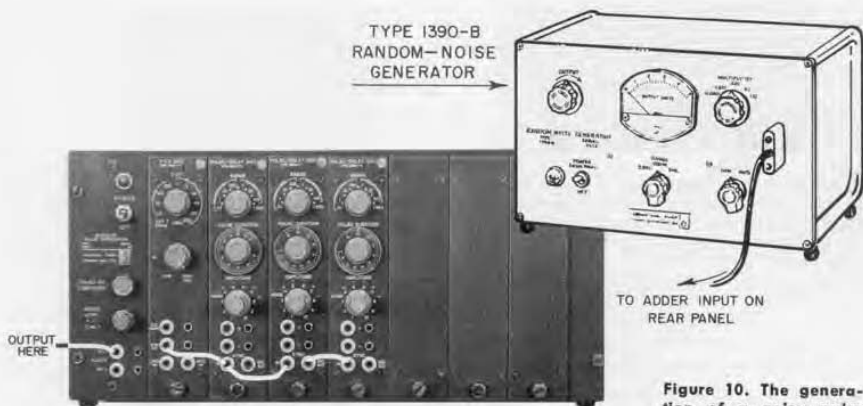

Figure 10. The generation of a noisy pulse train.

moment that the 300-microsecond pulse begins. After the 100-microsecond interval, the third Pulse/Delay Unit is triggered by the delayed output synchronizing signal. The third unit gives an output of 100 microseconds, which is switched to the same adder. Finally, a General Radio TYPE 1390-B Random-Noise Generator produces the noise to give the "dirty" signal of Figure 9a.

#### Will the Flip-Flop Work?

Some pulses are so called only as a matter of courtesy. In a world limited to finite rise times, there may be some question about just when a pulse *is* a pulse. A number of circuits such as gates, flip-flops, and other logic elements may change their behavior from *go* to *no-go* as their input signals become degraded. The effects of deteriorating rise and fall times are easily evaluated with the TYPE 1395-A Modular Pulse Generator, fitted out with the TYPE 1395-P3 Pulse Shaper.

The Pulse Shaper is basically a maker of slanting edges. It starts a leading edge upon receiving one input trigger

and starts the trailing edge when the next trigger comes along. Both leading and trailing edges are linear, rather than exponential. Both can be varied independently in duration within the same decade range. For example, the leading edge could rise in 17 microseconds and the trailing edge fall in 84, but 17 and 112 microseconds is not a possible combination. Trapezoids are readily made, and triangles are formed when the start of the trailing edge is moved up to the end of the leading edge.

Figure 11 illustrates the TYPE 1395-A Modular Pulse Generator connected to test the effect of rise time on a circuit. The objective is a pulse with a rise time of 100 nanoseconds, a fall time of 1000 nanoseconds, and a flat top lasting 2 microseconds. The pulse repetition frequency is set at 100 kc/s by the PRF Unit. (It should be noted that the Pulse Shaper draws a good deal more current than most of the other modules. To prevent connection of enough shapers to overload the power supplies, the shapers are keyed to fit only the three extreme right-hand positions.)





Figure 11. The basic Pulse Shaper arrangement.

An example of the output is shown in Figure 12. Here we see that the objectives in the preceding paragraph are indeed met. This oscillogram was taken under open-circuit conditions. The amplitude would be less under load, since the shaper output is basically from a current source. The Pulse Shaper may be connected to the adders; examples of what this may lead to are given later.

#### An Application to Component Testing

Small iron-core inductors, especially those wound on lossy material, are difficult to measure. Measurements made on a low-frequency bridge are plagued by a very small  $Q$ , because  $\omega L$  is low. With a high-frequency bridge, losses are high, and so  $Q$  is again low.

But consider the equation for the voltage across an inductor:

$$e = L \frac{di}{dt} + iR \quad (1)$$

If  $di/dt$  has a constant value, and the value of  $e$  across the coil may be measured, then  $L$  is readily found as

$$L = e \frac{\Delta t}{\Delta i} \quad (R \cong 0) \quad (2)$$

where  $\Delta$  rather than  $d$  notation is chosen for reasons that will be apparent.

The assumption of a constant  $di/dt$  is met well if a TYPE 1395-P3 Pulse

Shaper drives a smooth ramp of voltage into a high resistance. Suppose we try to set up a convenient scale — say 1 millivolt developed across the inductor corresponds to 10 microhenrys inductance.

Let  $L$  in Equation (2) be  $10^{-5}$  and  $e$  be  $10^{-3}$  volts. Solving for  $\Delta t/\Delta i$  gives  $10^{-2}$ . Picking a reasonable but arbitrary number for either quantity, suppose we make  $\Delta t = 5$  microseconds. Then  $\Delta i = 5 \times 10^{-6}/10^{-2} = 5 \times 10^{-4}$ , or 0.5 milliamperes. Then, if we had a current waveform that changed from 0 to 0.5 mA in 5 microseconds and impressed that current on the inductor, we would develop 1 millivolt for every 10 microhenrys. This current is easily achieved if the Pulse Shaper generates a 10-volt amplitude ramp in 5 microseconds and a 20,000-ohm precision resistor is connected between the shaper and the inductor, as shown in Figure 13.

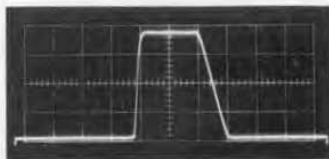

Figure 12. A pulse formed by the Type 1395-P3 Pulse Shaper. The rise time is 100 nanoseconds; the fall time is 1000 nanoseconds. Scale: Vertical, about 6 volts per major division; horizontal, 1 microsecond per major division.

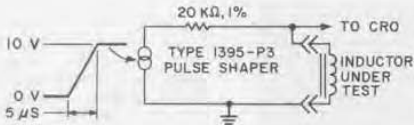

Figure 13. A calibrated tester for the inductance of small iron-core coils.

The actual interconnection of modules would be as in Figure 11, but with different settings of the knobs, of course.

Figure 14 shows the step of voltage applied to the 20,000-ohm resistor. This does indeed rise from 0 to 10 volts in 5 microseconds. The voltage across a sample inductor is illustrated in Figure 15. The transients at the leading edge are associated with stray capacitance and inductance and soon die out. From then on, the voltage remains quite steady for 5 microseconds and then drops to zero as the ramp ends and  $di/dt$  changes from a constant to 0. (Actually, there is a current flowing, even though  $di/dt$  is 0, and hence the  $iR$  drop in the inductor gives a small remaining voltage). The value of the inductor can be read right off the scope graticule. It is seen to be 830 microhenrys.

#### And Something for the Data-Processing Field

Data-processing, data-transmitting, and data-interpreting circuits and sys-

tems all require inputs for test purposes. Except for a little decade notation at the human-machine interface, binary is the rule. To those working with bits, we offer the TYPE 1395-P6 Word Generator.

As the name suggests, the Word Generator is designed to produce sequences of 1's and 0's. The built-in capacity is 16 bits. This may be shortened to 14 bits by means of a rear-panel switch. If one 16-bit unit is cascaded with one 14-bit unit, 30 bits are made available. Thus, just two Word Generators can provide any number of word lengths based on 32, 30, or 28. For example, four 7-bit words or six 5-bit words could be had. For those who prefer one-word-per-module of the bit length they please, any bit capacity from 2 to 16 can be had through changes in an internal plug-in patch wire. Any number of modules up to 7 can be cascaded, giving a maximum bit capacity in a TYPE 1395-A Main Frame of  $16 \times 7 = 112$ .

Another use for the Word Generator is as a digital scaler. For example, a Word Generator connected for 11-bit capacity will give one output for eleven inputs when just one bit switch is turned on. Larger ratios are achieved when we let one Word Generator drive another. The scaler of 11, for example,

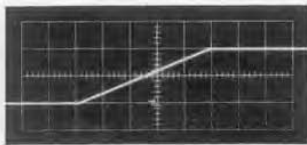

Figure 14. Voltage applied by the Type 1395-P3 Pulse Shaper to drive the inductance testing assembly. Scale: Vertical, 5 volts per major division; horizontal, 1 microsecond per major division.

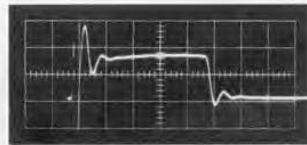

Figure 15. Voltage across an inductor tested by the arrangement in Figure 13. Scale: Vertical, 50 millivolts per major division; horizontal, 1 microsecond per major division. One millivolt represents 10 microhenrys inductance.

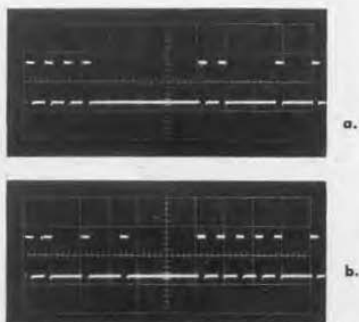

Figure 16. Patterns produced by the Type 1395-P6 Word Generator driving a Type 1395-P2 Pulse/Delay Unit. Positive pulses into 50-ohm loads, 3.5-microsecond duration, 100-kc bit rate, and 6.25-kc word rate.

(a) 16-bit word 1111000001100101

(b) 16-bit word 1101010001111101

could drive a second Word Generator connected for 14 bits, and the two together scale by a ratio of  $11 \times 14 = 154$ .

Figures 16a and b show two sample patterns set on Word Generators. Both use the 16-bit capacity. The connection of modules is very simple: a PRF Unit drives the Word Generator, and its output drives a Pulse/Delay Unit.

One extremely useful feature is that, unlike many similar devices, the TYPE 1395-P6 Word Generator is not limited to producing rectangular pulses. Its output is simply a set of trigger pulses, turned on or off at the front-panel switches. You can generate any pulse shapes you wish by letting these triggers drive other TYPE 1395 modules. An

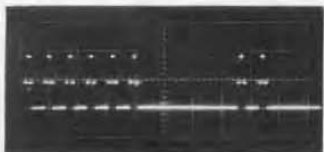

Figure 17. A 14-bit word of "top hat" pulses generated by a PRF Unit, a Word Generator, and three Pulse/Delay Units. Bit rate 10-kc, word rate about 714 words per second. Pattern is 11111100001100.

example is given in Figure 17, where a Word Generator connected for 14-bit capacity triggers other modules to generate a binary pattern of "top hat" pulses.

#### Is There an Application for This Pulse?

A device as versatile as the TYPE 1395-A Modular Pulse Generator will allow the creation of some weird waveforms indeed. Just as an example of what can be done, we point to Figure 18. This can only be described as a witch's hat sitting on a dented pedestal. It is produced by a combination of Pulse/Delay Units and a Pulse Shaper, all connected together via the built-in adder circuits. We have no idea what it might be used for.

#### DESIGN HIGHLIGHTS OF THE MODULAR PULSE GENERATOR

Earlier in this article, the performance of the General Radio TYPE

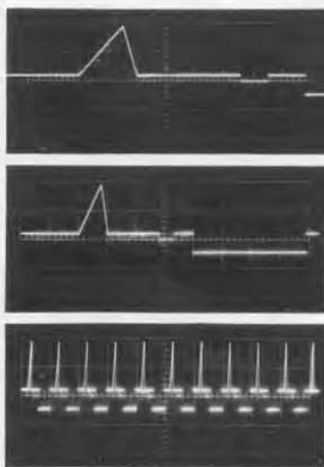

Figure 18. An example of the extraordinary pulse shapes that can be produced by the Type 1395-A Modular Pulse Generator. Scale: Vertical, all 0.5 volt per major division; horizontal: top, 50 microseconds per major division; center, 100 microseconds; bottom, 1 millisecond.

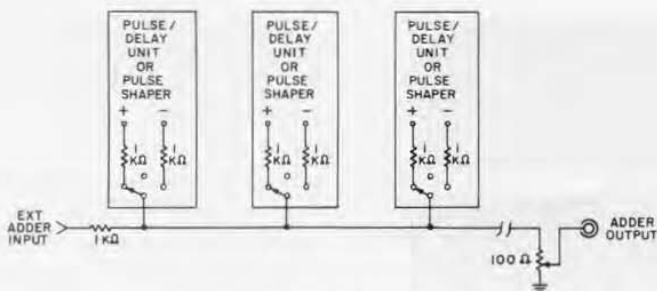

Figure 19. One of the adder circuits.

1217-C<sup>1</sup> was mentioned as a starting-point for the TYPE 1395-A Modular Pulse Generator. To those familiar with the TYPE 1217 in either its B or C versions, it will be interesting to note that the Type 1395-P1 PRF Unit and the TYPE 1395-P2 Pulse/Delay Unit together equal (approximately) one TYPE 1217-C Unit Pulse Generator.

The TYPE 1395-A Modular Pulse Generator contains a common power supply for operating as many as seven units. Some modules, such as the Pulse Shaper and the Power Amplifier, consume a considerable amount of current. Therefore, the output of the Pulse/Delay modules is limited to 20 mA to ensure there is enough power supply capability to operate any "mix" of modules that may be chosen.

We shall now look at some of the features and principles of operation

of the various Modular Pulse Generator units in more detail.

### The Adder System

A sketch, considerably simplified, of one adder is shown in Figure 19. Each module that can be connected to the adders is fitted out with a switch. This allows both the positive- and negative-polarity output pulses to be connected to either of the two adder busses. Another position allows the positive polarity to be connected to ADDER NO 1 and the negative polarity to ADDER NO 2. The actual output terminals are the source of the signals to the adders. Resistors of 1000 ohms are provided for buffering.

Resistive adders of this type are about the most trouble-free and wide-band adders that can be had. However, they do cost in terms of amplitude. The output signal from the adders will be appreciably less (more than 20 dB less) than the output directly from

<sup>1</sup> R. W. Frank, "Improved Performance from the Unit Pulse Generator," *General Radio Experimenter*, December 1964.

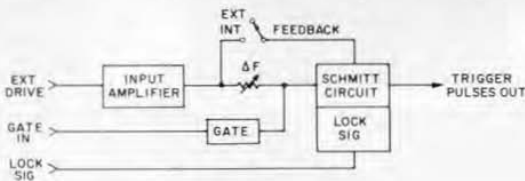

Figure 20. Block diagram of the Type 1395-P1 PRF Unit.



an individual module. The TYPE 1395-P4 Power Amplifier is recommended for bringing the signal level from an adder bus up to a higher level.

#### The Type 1395-P1 PRF Unit

A block diagram of the PRF module is shown in Figure 20. In the EXT DRIVE position, signals from the input amplifier trigger the Schmitt circuit. In the INTERNAL positions, the Schmitt circuit becomes a free-running oscillator. In either case, the grid can be clamped by the GATE circuit to stop operation. The LOCK SIGNAL injects synchronizing signals into the Schmitt circuit to tie its operating frequency to that of an external source, usually for frequency-dividing purposes.

More details of the circuit operation can be seen in Figure 21. Note that the GATE IN and LOCK SIGNAL tubes ( $V103B$  and  $V103A$ , respectively) are normally biased below cutoff. On the GATE IN terminal, a signal that moves

the grid of  $V103B$  more positive than about  $-1.5$  volts will cause the production of pulses to cease. The LOCK SIGNAL terminal requires about 10 volts, peak, (i.e., pulses 10 volts in amplitude or sine waves of 7+ volts, rms) to start  $V103A$  into conduction. Once  $V103A$  does conduct, it raises the potential on timing capacitor  $C$  and causes the grid of Schmitt trigger tube  $V102A$  to rise in potential. If the Schmitt circuit was about to fire anyway, the voltage rise transmitted through  $C$  will make it fire at once, and thus the Schmitt trigger locks in with the external synchronizing signal.

Capacitor  $C$  is simply a representation of any of ten different capacitors that are switched into the circuit as the frequency range is varied. Within any range, vernier frequency control is achieved by adjustment of  $R103$ . The time constant  $(R102 + R103) C$  is the chief determinant of the operating frequency.

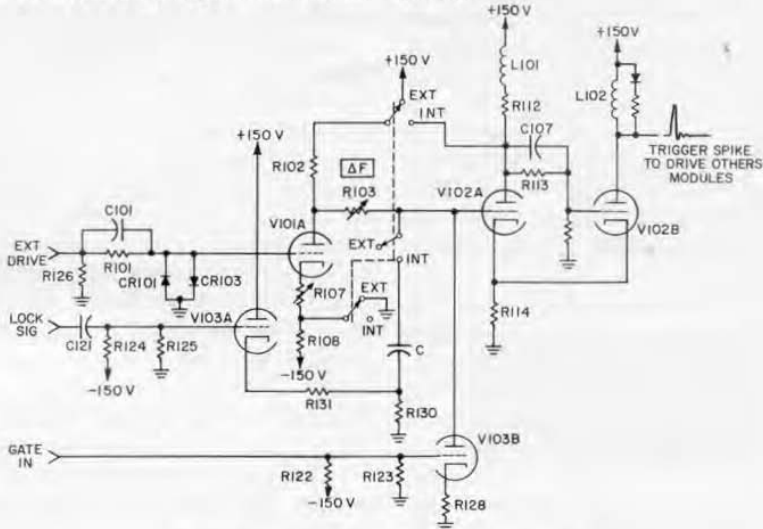

Figure 21. The chief circuits in the PRF module.

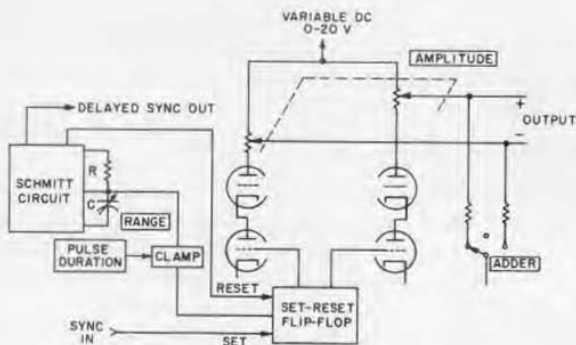

Figure 22. Block diagram of the Type 1395-P2 Pulse/Delay Unit.

### The Type 1395-P2 Pulse/Delay Unit

Figure 22 is a block diagram of the Pulse/Delay Unit. The SYNC IN pulse from a PRF Unit "sets" a set-reset flip-flop. The act of setting it turns on one output tube and turns off the other. In this way, both the negative and positive pulses are generated. At the same time, a clamp is released from the Schmitt circuit. This permits the RC network to start charging to a voltage level that will trigger the Schmitt. The releasing of the clamp also deposits a controlled amount of initial charge into capacitor C. The more charge, the sooner the added charge entering through resistor R will develop enough voltage to fire the Schmitt. Therefore, the pre-charge controls the pulse duration within the range selected by the value of capacitor C.

As soon as the Schmitt circuit triggers, it generates a DELAYED SYNC OUTPUT pulse. This is available at the front panel for any purposes requiring time delay (see, for example, Figures 2 and 3). Simultaneously, a reset pulse is generated to return the flip-flop to its original state, and the pulse-generating sequence ends.

It is seen in Figure 22 that the output

tubes obtain their power from a variable dc supply. This is built into the TYPE 1395-A Modular Pulse Generator and adjusted from the front panel with a knob marked PULSE DC COMPONENT. The setting of this knob allows the output pulse to be placed anywhere relative to ground, from entirely below ground to entirely above.

### The Type 1395-P3 Pulse Shaper

The Pulse Shaper generates leading and trailing edges of straight-line form rather than exponential. This result is achieved by the charge and discharge of a capacitor through constant-current sources. These sources take the form of grounded-base silicon transistors, which receive their emitter currents from large, although variable, resistors connected to the +150- and -150-volt power supplies in the main frame.

A circuit diagram of the pulse-shaping portion of the device is shown in Figure 23. The input stage is a set-reset flip-flop. A trigger pulse applied to INPUT 1 starts the leading edges, and a trigger applied to INPUT 2 starts the trailing edge. If there is no signal at INPUT 2, the flip-flop operates in a complementing mode, giving symmetri-

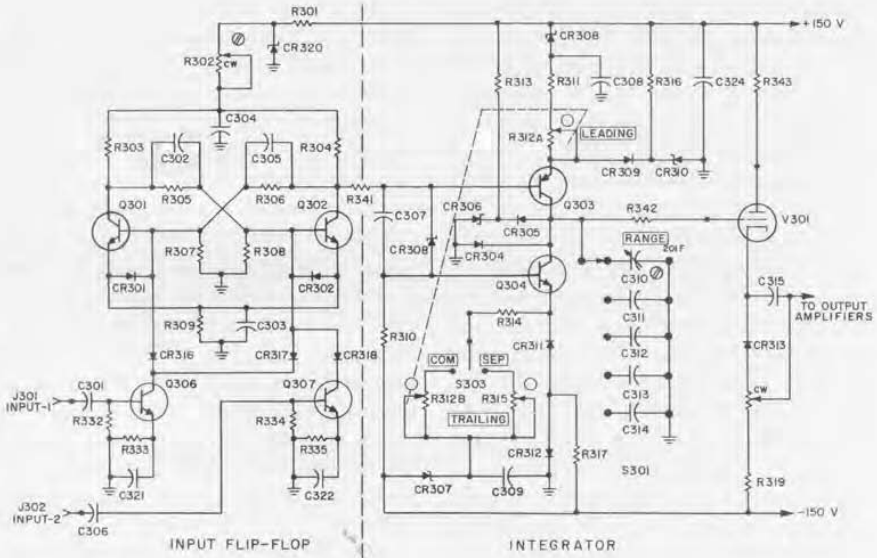

Figure 23. The pulse-shaping circuits of the Type 1395-P3 Pulse Shaper.

cal operation in the sense of equal time intervals between the start of leading and trailing edges.

The state of the flip-flop commands either *Q303* or *Q304* to conduct. *Q303* charges whichever capacitor is selected by the RANGE switch, and *Q304* discharges it. Diodes *CR309*, *CR310*, *CR311*, *CR312*, *CR304*, *CR305*, and *CR306* act as various clamps or reference voltages to limit voltage swings and to protect the transistors. Resistors *R312A*, *R312B*, and *R315* determine the emitter currents in *Q303* and *Q304* and thereby act as vernier controls on the rise and fall times of the pulse edges.

The output stage is not shown, since it does not differ significantly in end results from that of the Pulse/Delay Unit. However, in order to achieve

linear operation, it is designed as a long-tailed pair with a constant-current source in the common cathode lead.

Just how straight the leading and trailing edges are is a fair question. We are prepared to answer. Most of the engineers who read this article will recall their freshman mechanical-drawing class and how they were told to check a straight-edge for straightness.

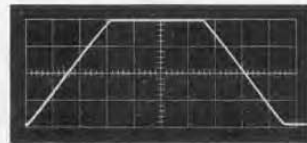

Figure 24. A demonstration of the linearity of the edges in the Type 1395-P3 Pulse Shaper. Scale: Vertical, about 4 volts per major division; horizontal, 3 microseconds per major division.



Draw a line, turn the straight-edge over, and see how close another line will fall on top of the first one. We have done this in Figure 24. A dual-trace oscilloscope was connected with the "A" channel on the positive output terminal of the Pulse Shaper. The "B" channel was switched to invert its display and connected to the negative output terminal of the Pulse Shaper. This results in two positive-going trapezoidal pulses being displayed on alternate channels. They may differ slightly in amplitude because the output potentiometers in the two Pulse Shaper channels are not identical. Since linearity rather than amplitude is undergoing scrutiny, we felt it would not be cheating to make the display heights equal on the CRO screen. The two traces were then superimposed as nearly as possible, with the result shown in Figure 24. Remember this figure shows departures from linearity not only in the Pulse Shaper but in the CRO circuits as well. We are almost embarrassed to print this photograph — it looks like a fraud, but it isn't.

#### The Type 1395-P4 Power Amplifier

We have not said much about this amplifier heretofore. An amplifier just isn't as exciting as some of the pulse circuits. Nevertheless, it is worthwhile to point out its main features.

Three output impedances are available: 50 ohms, 93 ohms, and 600 ohms. These impedances allow matching to most of the common transmission lines encountered in pulse and telephone practice. Likewise, the input impedance is variable from 50 ohms to 1050 ohms permitting the Power Amplifier to terminate transmission lines on the receiving end as well as the sending.

The Power Amplifier has been designed as a linear amplifier. This is true even though it will deal with pulses most of the time. Unlike the pulse amplifiers that are really high-powered switches, an amplifier that reproduces pulses of complex shape must be "hi-fi" in good measure. A photograph similar to that of Figure 24 was taken in the course of work on this article, but the waveforms showing the input and output from the Power Amplifier so nearly coincided that the difference would have vanished in the course of preparing the engravings for printing. It must be confessed that, seen on the oscilloscope, the two traces diverged in the center by about the width of the trace on the cathode-ray tube phosphor.

The Power Amplifier employs a unique protective circuit. A small lamp bulb, of the type usually used in pilot lights, is in series with the +150-volt lead, and a second lamp in series with the -150-volt lead. Both of these are mounted in a light-tight plastic can, together with a photoresistor. The photoresistor is in a voltage divider arrangement connected to the grid of a tube that controls an overload relay. If either the +150 or -150 supply tries to draw excessive current, its lamp glows and changes the resistance of the photoresistor. This alters the grid bias, and the tube switches the relay, turning off the power to the amplifier.

The Power Amplifier is not direct-coupled and will not retain the dc level of the input signal. However, a DC COMPONENT control makes it possible to shift the dc level of output pulses from at least -1.5 volts to at least +1.5 volts with a 50-ohm load, and more with loads of higher impedance.



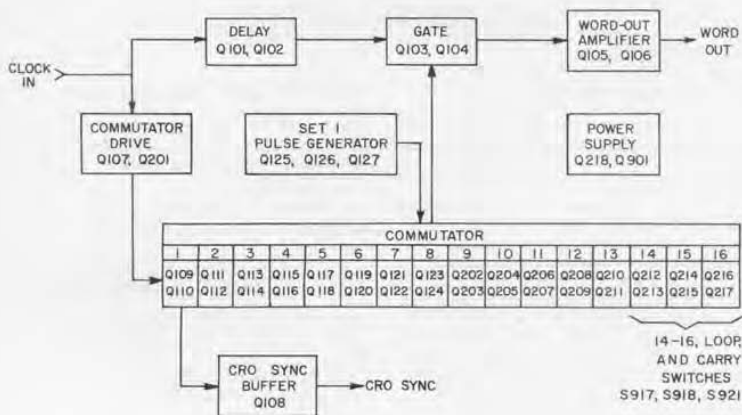

Figure 25. Block diagram of the Word Generator module.

### The Type 1395-P6 Word Generator

A block diagram of the Word Generator is given in Figure 25. The Word Generator may be visualized as a commutator sweeping around to a number of contact points, usually either 14 or 16. After it comes to rest at each point, a pulse is applied to the commutator. If the switch between the contact point and the gate ( $Q103-Q104$ ) is closed, the pulse goes to the output stages ( $Q105-Q106$ ) and appears at the WORD OUT terminal. The rate at which the commutator moves around is determined by the frequency applied to the CLOCK IN terminal. In other words, this frequency is the bit rate. The word rate is the bit rate divided by 14, 16, or whatever other bit capacity may have been connected by the internal patch wire.

Whenever the commutator comes to rest in the No. 1 position, a pulse is generated in the crosync buffer ( $Q108$ ). This permits an oscilloscope to be synchronized to the word rate rather than the bit rate and prevents the scope from locking to some pulse in the

pattern, which would change with every change in the word set on the front panel switches.

If greater bit capacity is desired, the commutator is "broken open" and another commutator is spliced in from another Word Generator. Naturally, this is all handled by switches and interconnections within the TYPE 1395-A Modular Pulse Generator. Up to seven units, the capacity of a complete main frame, can be employed, giving 112 as the maximum number of bits that can form a single word.

### WHAT COMES NEXT?

Other modules are currently under development. If any of you who read this article feel some particular device would be an especially welcome addition, we would appreciate hearing from you.

— GORDON R. PARTRIDGE

### ACKNOWLEDGMENTS

The TYPE 1395-A Modular Pulse Generator was conceived by Mr. R. W. Frank, who also did a goodly portion of the early development of the instrument.

— GORDON R. PARTRIDGE



## SPECIFICATIONS

## MAIN FRAME

**ADDER Output Level:** 0 to 1 V or more, depending on number of modules used (continuously adjustable).

**ADDER Output Impedance:** 100  $\Omega$  or less (100- $\Omega$  pot).

**PULSE DC COMPONENT Range:** 0 to +20 V (continuously adjustable).

**Power Required:** 105 to 125 V, 195 to 235 V, or 210 to 250 V, 50 to 60 c/s; approximately 250 W, depending on quantity and type of plug-ins.

**Accessories Supplied:** Type CAP-22 Power Cord; spare fuses; six patch cords — one each TYPES 274-LMB and 274-LMR, two each TYPES 274-LSB and 274-LSR; four blank cover panels; one 14-conductor module extension cable.

**Accessories Available:** All modules in the TYPE 1395 series, TYPE 1217-P2 Single-Pulse Trigger.

**Mounting:** Rack-bench cabinet.

**Dimensions:** Bench model — width 19, height 9 $\frac{1}{2}$ , depth 14 $\frac{1}{2}$  inches (485 by 230 by 370 mm), over-all; rack model — panel 19 by 8 $\frac{3}{4}$  inches (485 by 220 mm), depth behind panel 13 $\frac{1}{4}$  inches (340 mm).

**Net Weight (without modules):** Bench model, 29 lb (13.2 kg); rack model, 27 lb (12.3 kg).

**Shipping Weight (without modules):** 42 lb (19.5 kg).

## TYPE 1395-P1 PRF UNIT

## PULSE REPETITION FREQUENCY

**Internally Generated:** 2.5 c/s to 1.2 Mc/s with 12-position switch and uncalibrated  $\Delta F$  control.

**Externally Controlled:** After adjustment for maximum sensitivity, sine-wave input of 0.5 V, rms, required for prf from dc to 0.5 Mc/s, rising to 1.5 V, rms, at 2 Mc/s. Input impedance at 0.5 V is approx 100 k $\Omega$  shunted by 50 pF. Non-sinusoidal signal requires a negative-going step of 1 V.

## INPUT AND OUTPUT SIGNALS

**Sync Out Pulses:** At least 10 V, positive, with duration between 75 and 150 ns (nominally 100 ns); rise time approx 25 ns and output impedance approx 35  $\Omega$ .

**Lock Signal:** PRF Unit operating at 1 kc/s can be locked to a frequency of 10 kc/s by 10-V positive pulses with 100-ns duration or with a sine wave of 7 V, rms. Required positive-pulse amplitude increases to about 12 V to lock the 1 kc/s to a frequency of 2 kc/s.

**Gate Input:** A potential more positive than -1 V at this terminal stops the generation of SYNC OUT pulses.

**Stability:** Prf jitter is 0.05% when the PRF Unit is operated from the power supply in the TYPE 1395-A main frame.

## GENERAL

**Power Consumption:** +150 V at 25 mA; -150 V at 5 mA; +15 V at 5 mA; 6.3 V, 60 c/s, 1 A.

**Accessories Supplied:** Six patch cords — one each TYPES 274-LMB and 274-LMR, two each TYPES 274-LSB and 274-LSR; two insulated plugs, one each TYPES 274-DB1 and 274-DB2.

**Accessories Available:** TYPE 1217-P2 Single-Pulse Trigger, other TYPE 1395 modules.

**Net Weight:** 1 $\frac{1}{2}$  lb (0.7 kg).

**Shipping Weight:** 4 $\frac{1}{2}$  lb (2.1 kg).

## TYPE 1395-P2 PULSE/DELAY UNIT

**Pulse and Delay Durations:** 100 ns to 1 s, accurate to  $\pm 5\%$  of reading or  $\pm 2\%$  of full scale, or  $\pm 35$  ns, whichever is greater.

**Pulse Repetition Frequency:** Determined by input sync signal — range dc to 2.4 Mc/s. Input signals can be randomly spaced if separated by at least 400 ns.

**Rise and Fall Times:** Less than 15 ns with 50- $\Omega$  load. On high-voltage output (20 V into 1 k $\Omega$ ), transitions are typically 80 ns + 2 ns/pF of load capacitance.

**Output Voltage:**  $\pm 20$  V pulses into 1-k $\Omega$  internal load impedance ( $\pm 1$  V into 50- $\Omega$  load).

**Input Sync Requirements:** Positive-going pulse, 10 to 20 V, with 75- to 150-ns duration.

**Delayed Output:** Positive pulse of at least 10-V amplitude and 75- to 150-ns duration. Output impedance approx 125  $\Omega$ . Time between SYNC IN and DEL OUT pulses set by PULSE DURATION control.

**Stability:** Pulse-duration jitter is 0.05% when Pulse/Delay Unit is operated in the TYPE 1395-A main frame.

**Power Consumption:** +150 V at 15 mA; -150 V at 30 mA; 6.3 V, 60 c/s, 0.7 A; 6.3 V, 60 c/s, 1.3 A; +15 V at 5 mA; 0 to +20 V, variable, at 25 mA.

**Accessories Supplied:** Five patch cords — two each TYPES 274-LSB and 274-LSR, one TYPE 274-LMR; two insulated plugs, one each TYPES 274-DB1 and 274-DB2.

**Net Weight:** 1 $\frac{3}{4}$  lb (0.8 kg).

**Shipping Weight:** 4 $\frac{3}{4}$  lb (2.2 kg).

## TYPE 1395-P3 PULSE SHAPER

**INPUT PULSES:** 10 V to 20 V in amplitude and 75 ns minimum duration.

## OUTPUT PULSES

**Duration:** Time between pulses at IN 1 and IN 2 plus duration of trailing edge.

**Rise and Fall Times:** 100 ns to 10 ms in five decade ranges,  $\pm 10\%$  of full scale, from the 0 to 100% points. Rise and fall times can be adjusted, independently by separate controls or simultaneously by a single control, within the same decade range. To obtain times less than a few hundred nanoseconds, output must be terminated in 50 to 100  $\Omega$ .



**Linearity:** A leading or trailing edge voltage  $e(t)$  making a transition of  $E$  volts in time  $T$  will not at any time  $t$  depart from the

equation  $e = \frac{Et}{T}$  ( $0 \leq t \leq T$ ) by more than

0.1  $E$  (typically better than 0.05  $E$ ). The fastest transitions will not yield this performance unless outputs are terminated in 50 to 100  $\Omega$ .

**Voltage:**  $\pm 20$ -V pulses into 1-k $\Omega$  internal load impedance ( $\pm 1$  V into 50- $\Omega$  load).

#### GENERAL

**Power Consumption:** +150 V at 45 mA; -150 V at 55 mA; 6.3 V, 60 c/s, 0.15 A; 6.3 V, 60 c/s, 0.6 A; 0 to +20 V, variable, at 30 mA.

**Accessories Supplied:** Five patch cords — two each TYPES 274-LSB and 274-LSR, one TYPE 274-LMR; two insulated plugs, one each TYPES 274-DB1 and 274-DB2.

**Net Weight:** 1 $\frac{3}{4}$  lb (0.8 kg).

**Shipping Weight:** 4 $\frac{3}{4}$  lb (2.2 kg).

### TYPE 1395-P4 POWER AMPLIFIER

**Output Impedances:** 50, 93, and 600  $\Omega$ , all  $\pm 10\%$ .

**Gains:** 20, 20, and 26 dB, respectively, at the above impedances and with matched loads, all  $\pm 2$  dB.

**Pulse Output Voltage:**  $\pm 20$  V pulses into 50- $\Omega$  load with 10% duty cycle. Larger duty cycles may be used at lower output levels.

**Rise and Fall Times:** Less than 60 ns on all transitions with a 50- $\Omega$  load and selector switch set for 50- $\Omega$  impedance.

**Sine-Wave Amplifier:** Power output into 50- and 93- $\Omega$  loads is at least 2.5 W (3% distortion typical); into 600- $\Omega$  load, at least 1.5 W (distortion, 1.5% typical).

**Frequency Response:** Down less than 3 dB at 20 c/s and 5 Mc/s with 50- and 93- $\Omega$  loads; 20 c/s and 1.5 Mc/s with 600- $\Omega$  load.

**Dc Level:** Dc baseline of pulses and centerline of sine waves can be moved at least  $\pm 1.5$  V, dc with 50- $\Omega$  loads, and more with higher impedance loads.

**Input Impedance:** Adjustable from 50 to 1050  $\Omega$ , shunted by approx 45 pF.

**Power Consumption:** +150 V at 150 mA, max; -150 V at 150 mA, max; 6.3 V, 60 c/s, 2.2 A; 6.3 V, 60 c/s, 1.9 A.

**Accessories Supplied:** Four patch cords — one each TYPES 274-LMB, 274-LMR, 274-LSB, and 274-LSR; two insulated plugs, one each TYPES 274-DB1 and 274-DB2.

**Net Weight:** 2 lb (1 kg).

**Shipping Weight:** 5 lb (2.3 kg).

### TYPE 1395-P6 WORD GENERATOR

#### INPUT

**Pulse Repetition Frequency:** Dc to 2.5 Mc/s, externally controlled by TYPE 1395-P1 PRF Unit (or similar unit).

**Trigger-Pulse Requirements:** 10- to 20-V positive-going pulses of 75- to 150-ns duration. Square waves can be used above 10 kc/s; sine waves, above 500 kc/s.

**Impedance:** 400 to 600  $\Omega$ , depending upon trigger amplitude.

#### OUTPUTS

**Word Out:** 10- to 20-V positive-going pulses of 75- to 150-ns duration. Output impedance approx 150  $\Omega$ , but termination in 500 to 1000  $\Omega$  is recommended.

**Pattern:** Set by front-panel switches. Choice of 16-bit or 14-bit capacity by rear-panel switch. One can achieve capacities other than 14 and 16 by modification of internal wiring. Interconnection of up to seven units provided by the TYPE 1395-A Main Frame.

**Oscilloscope Sync:** Rectangular pulse of 2-V min amplitude and duration equal to period of driving-signal prf. Occurs approx 50 ns before the Switch #1 output pulse, whether or not the switch is on.

#### GENERAL

**Power Consumption:** +15 V at 5 mA; 6.3 V, 60 c/s, 0.8 A.

**Accessories Supplied:** Five patch cords — one each TYPES 274-LSB, 274-LSR, 274-LMB, 274-LMR, and 274-LLR; two insulated plugs, one each TYPES 274-DB1 and 274-DB2.

**Net Weight:** 2 $\frac{1}{2}$  lb (1.2 kg).

**Shipping Weight:** 5 $\frac{1}{2}$  lb (2.5 kg).

### TYPE 1395-P7 SKELETON FRAME

A blank module suitable for mounting the components of a user-designed circuit.

**Dimensions:** Width 2 $\frac{1}{8}$ , height 8 $\frac{1}{2}$ , depth 5 in (55, 220, 130 mm), over-all.

**Net Weight:**  $\frac{1}{2}$  lb (0.3 kg).

**Shipping Weight:** 3 $\frac{1}{2}$  lb (1.6 kg).

Catalog Number	Description	Price in USA
1395-9801	Type 1395-A Modular Pulse Generator, Bench Model	\$500.00
1395-9811	Type 1395-A Modular Pulse Generator, Rack Model	500.00
1395-9601	Type 1395-P1 PRF Unit	150.00
1395-9602	Type 1395-P2 Pulse/Delay Unit	165.00
1395-9603	Type 1395-P3 Pulse Shaper	375.00
1395-9604	Type 1395-P4 Power Amplifier	250.00
1395-9606	Type 1395-P6 Word Generator	400.00
1393-9607	Type 1395-P7 Skeleton Frame	12.00



Figure 1. Panel view of the Type 1162-AR7C Coherent Decade Frequency Synthesizer with programmable decades. See complete listing of models on page 24.

## REMOTE PROGRAMMING FOR GR SYNTHESIZERS

When the first two GR synthesizers were described in the September 1964 issue, provision for remote frequency selection was mentioned only briefly. The RDI-1 Remote Digit-Insertion Unit is now in production and is described in this article. One of the outstanding characteristics of the GR synthesizers is their modular design. This permits initial choice of resolution to satisfy a particular need while retaining full flexibility for future expansion. In a logical extension of the modular concept, remote programming is offered now as an option.

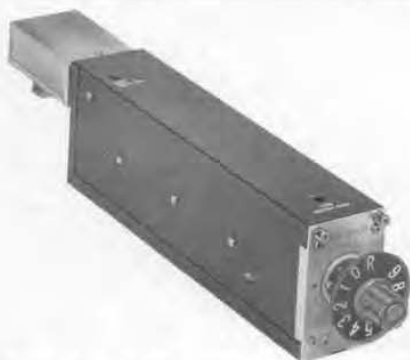

Figure 2. View of the Type 1160-RDI-1 Digit-Insertion Unit. The filter and matrix plug can be seen projecting from the rear.

The TYPE 1160-RDI-1 Digit-Insertion Unit (Figure 2), together with its filter and matrix plug and remote cabling, brings to the GR synthesizer line *complete* or *partial* remote frequency programming at the user's option. The RDI-1 can be used in all digit stations in the TYPE 1161-A and TYPE 1162-A Synthesizers, and in all but the 1-Mc station in the TYPE 1163-A. In all cases, it is directly and quickly interchangeable with the DI-1 unit. Control can easily be transferred digit by digit from remote to manual, lending additional flexibility.

During the development of the GR synthesizers, it became apparent that these generators, by their very nature, are more readily programmed than are conventional signal sources. While a necessity in certain applications, a programming capability obviously adds to the price and complexity of the instrument for users not requiring it. Hence, remote programming is offered as an option.

In the design of the plug-in Digit-Insertion Units, space was provided for the additional elements necessary

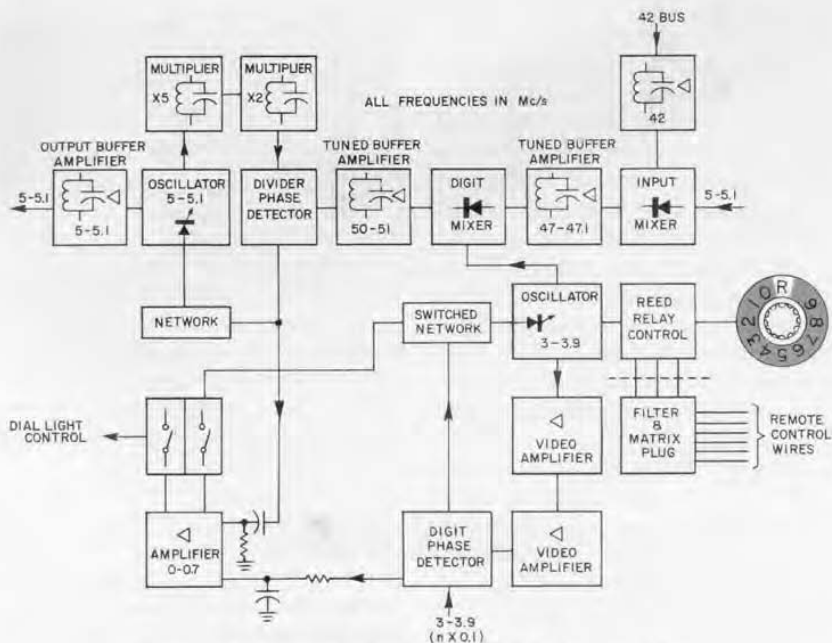

Figure 3. Block diagram of the RDI-1 Remote Digit-Insertion Unit.

for remote operation. It was also considered desirable that a programmable module be capable of manual operation. Taking full advantage of the unique packaging of the DI units, the RDI-1 is so designed that it uses a maximum of common parts with the DI-1. The RDI-1 dial has the usual ten positions, 0 to 9, and an 11th position marked R, in which frequency selection is made by contact closure on the remote wires. If the dial is moved from the R position, the manual selection overrides the remotely programmed information.

As can be seen in the block diagram in Figure 3, selection of a digit in the RDI-1 is accomplished by the change of frequency in the so-called digit oscillator, which for each setting is locked to a "picket fence" of standard frequen-

cies from 3.0 to 3.9 Mc/s in 100-ke steps. Capacitors in the digit-oscillator circuit are switched by low-loss, rf-type reed relays. The reed driver coils are energized from the internal supply but can also be operated from an external supply. To select a particular digit, one has merely to establish connection between the designated digit wire and the common wire.

The reed relays are directly associated with the rf circuitry in the digit oscillator, and capacitive coupling exists to the driver coils. To reduce rf voltages on the remote wiring, an internal two-section filter is used, which reduces the rf level to approximately  $50 \mu\text{V}$ . In addition, the cable supplied has a grounded shield to prevent RFI. The components of this filter are housed



in a small, separate, plug-in shield engaging a connector that protrudes from the rear of the RDI (Figure 2). This filter plug also contains the diode matrix that converts from an internal biquinary code to a 10-line code. The unit can be remotely programmed in either code; the filter plug is normally wired for 10-line, but removal of one jumper wire converts it to the biquinary code. In the latter mode of operation, the digit 9 is produced with no external closures; 8, 7, 6, 5 are selected by connection of the appropriate wire to the common wire. The lower digits 4, 3, 2, 1, 0 are obtained with the same closures used already for the higher digits but with the additional closure of a range (or shift) wire to common. The 8 wire produces digit 3 when connected to common, 7 selects digit 2, and so on. In the 10-line mode, where one wire corresponds to each digit, the digit 9 is also selected with no closures. The 12 leads in the cable supplied are the maximum needed (10-line with external power).

A device is suitable for direct connection to the RDI-1's if it provides either

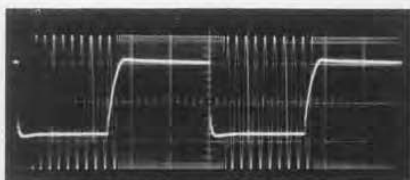

Figure 4. Oscillogram showing switching time (see text).

mechanical or electrical contact closure in the 10-line or biquinary form and maintains continuous closure as long as a particular frequency setting is desired. If a transistor switch is used, voltage drop must not exceed 0.5 volt for currents from 2.5 to 9 mA. The internal supply places the common lead at ground potential, whereas the open wires are at +18 volts with respect to ground. With an external supply of 18 volts, these potentials can be moved up to +50 and +32 volts (common) and to -32 and -50 (common). Voltages inside this range are acceptable; 18 volts are required to operate the relays, and the common must be negative. For operation with external supply, two jumper wires are removed in the RDI-1. This should facilitate

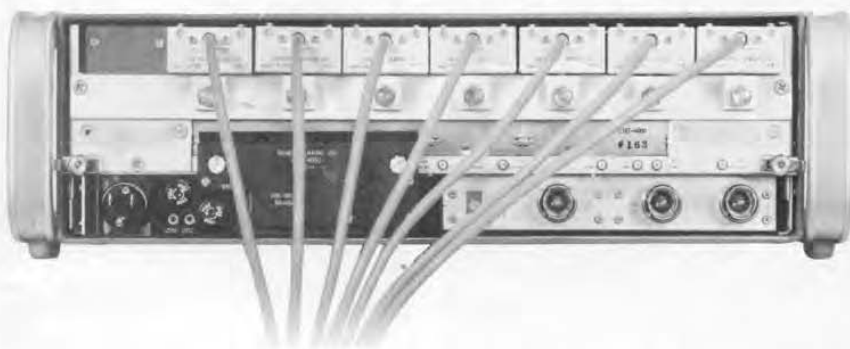

Figure 5. Rear view of the synthesizer of Figure 1, showing plug-in filters and remote cabling.





direct tie-in with existing equipment, particularly with transistor-switch output.

Many applications will require the programming of synthesizer frequencies by digital equipment in binary-coded decimals. Storage may be called for if entry is in serial rather than in parallel form. Suitable conversion equipment is under consideration.

The reed relays combine simplicity of circuitry with speed sufficient for most applications. Switching time is less than 2 milliseconds. This is the time interval between the external contact closure and the presence of the

newly selected frequency. The actual transition from one frequency to another is appreciably faster as can be seen in Figure 4, which shows a switch from 9.0924 kc/s to 2.0361 kc/s. The heavy trace is the voltage across the external contact (of the first digit). The lower portion shows closed contact (0 volts) and the upper portion open contact. Time scale is 2 ms/cm.

The capability of fast, remote frequency selection adds another dimension of versatility to the GR synthesizer line, thus opening up a new range of applications.

— G. H. LOHRER

## SPECIFICATIONS

**Switching Speed:** 2 ms or less.

**Code:** 10-line or biquinary (contact closure).

**Power:** Internal supply, provision for external supply 18 V, 9 mA.

**Net Weight:** 1½ lb (0.7 kg).

Instrument specifications of the TYPES 1161-A, 1162-A, and 1163-A remain unchanged if RDI-1's are substituted for DI-1 units.

Catalog Number	Description	Price in USA
1160-9479	Type 1160-RDI-1 Digit-Insertion Unit (Remote or manual control), including Filter Plug	\$535.00

*Sold only as replacements or to fill out partially equipped synthesizers.*

## HOOK-UP CABLE FOR RDI-1

A special, 12-conductor, shielded cable is recommended for connection of the 12-pin filter-plug to remote equipment. One 50-foot roll of cable is furnished with each synthesizer con-

taining an RDI-1 unit but is not supplied with an individually purchased RDI-1. Additional 50-foot lengths can be ordered separately.

**Net Weight:** 2½ lb (1.2 kg).

Catalog Number	Description	Price in USA
1160-9650	Hook-Up Cable for RDI-1, 50 feet	\$15.00



## COMPLETE SYNTHESIZERS FOR PROGRAMMABLE OPERATION

The TYPE 1161-A (0 to 100 kc/s) and TYPE 1162-A (0 to 1 Mc/s) Synthesizers are now available equipped with RDI units. For synthesizer specifications, see the *Experimenter* for September 1964.

## TYPE 1162-A COHERENT DECADE FREQUENCY SYNTHESIZER 0 to 1 Mc/s

Catalog Number	Type	Units Included	Calibrated Digits		Smallest Step (Digits Only)	Price in USA
			Decades Only	Decades + CAD*		
1162-9527	1162-AR7C	7 RDI Units + CAD	7	9	0.1 c/s	\$6195.00
1162-9526	1162-AR6C	6 RDI Units + CAD	6	8	1 c/s	5670.00
1162-9525	1162-AR5C	5 RDI Units + CAD	5	7	10 c/s	5145.00
1162-9524	1162-AR4C	4 RDI Units + CAD	4	6	100 c/s	4620.00
1162-9523	1162-AR3C	3 RDI Units + CAD	3	5	1 kc/s	4095.00
1162-9507	1162-AR7	7 RDI Units	7		0.1 c/s	5695.00
1162-9506	1162-AR6	6 RDI Units	6		1 c/s	5170.00
1162-9505	1162-AR5	5 RDI Units	5		10 c/s	4645.00
1162-9504	1162-AR4	4 RDI Units	4		100 c/s	4120.00
1162-9503	1162-AR3	3 RDI Units	3		1 kc/s	3595.00

## TYPE 1161-A COHERENT DECADE FREQUENCY SYNTHESIZER 0 to 100 kc/s

Catalog Number	Type	Units Included	Calibrated Digits		Smallest Step (Digits Only)	Price in USA
			Decades Only	Decades + CAD*		
1161-9527	1161-AR7C	7 RDI Units + CAD	7	9	0.01 c/s	\$6055.00
1161-9526	1161-AR6C	6 RDI Units + CAD	6	8	0.1 c/s	5530.00
1161-9525	1161-AR5C	5 RDI Units + CAD	5	7	1.0 c/s	5005.00
1161-9524	1161-AR4C	4 RDI Units + CAD	4	6	10 c/s	4480.00
1161-9523	1161-AR3C	3 RDI Units + CAD	3	5	100 c/s	3955.00
1161-9507	1161-AR7	7 RDI Units	7		0.01 c/s	5555.00
1161-9506	1161-AR6	6 RDI Units	6		0.1 c/s	5030.00
1161-9505	1161-AR5	5 RDI Units	5		1.0 c/s	4505.00
1161-9504	1161-AR4	4 RDI Units	4		10 c/s	3980.00
1161-9503	1161-AR3	3 RDI Units	3		100 c/s	3455.00

\* Direct reading. If CAD is calibrated in terms of the step decades, at least one more significant figure can be added. U. S. Patent No. 2,548,457. Patents applied for.

## NEW GRO REPRESENTATIVE FOR NORWAY

We announce the appointment of the Norwegian firm of Gustav A. Ring A/S as exclusive General Radio Company (Overseas) representative for Norway, succeeding the firm of Maskin-Aktieselskapet Zeta, who have represented us in that country since 1948. Effective in *February, 1965*, Gustav A. Ring A/S took over these responsibilities, and is now directly serving our

customers in Norway with competent technical assistance.

All inquiries, whether technical or commercial, concerning General Radio products should be addressed to:

Gustav A. Ring A/S

Sørkedalsveien 33

Oslo 3, Norway

Tel 46 68 90 • Telex 6234 • GARING

